

# FASTBOOK<sup>®</sup>

## SYSTEMS



## UMRISSLEUCHE

Um eine flexible und optimale Anbringung zu ermöglichen, bieten wir unsere Umrissleuchten mit verschiedenen Befestigungswinkeln an. Somit wird die Begrenzung des Fahrzeuges sichtbar gemacht und mehr Sicherheit garantiert.

## END OUTLINE MARKER

In order to allow a flexible and optimal mounting, we offer our end outline marker lamps with various mounting brackets. Thus, the boundary of the vehicle is made visible and more safety is guaranteed.

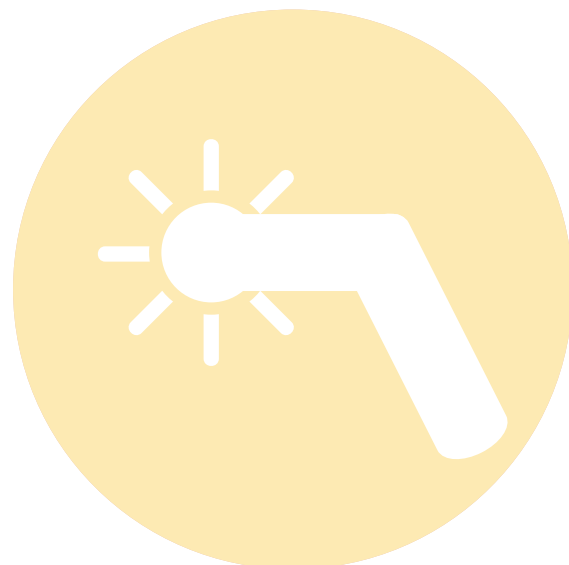



# SUPERPOINT IV LED

ADR Zone 2 IP 69K



Produktinformation  
Product information

[A1]

[A2]

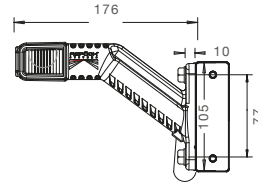
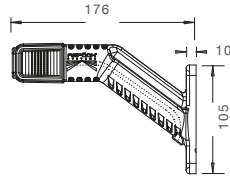

Umrissleuchte  
End outline marker

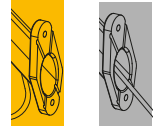

BEST. NR						ZUSATZ	ANSCHLUSS
PART NO						ADD ON	CONNECTOR
31-3104-004	1/30	●		LED	12V 24V	[A1]	P&R  2,00 m
31-3105-004	1/10	●		LED	12V 24V	[A1]	2 pol. ASS2   2 pin ASS2 2,00 m
31-3103-034	1/20	●		LED	12V 24V	[A1]	2 pol. Superseal   2 pin Superseal 1,00 m
31-3104-014	1/50		●	LED	12V 24V	[A1]	P&R  2,00 m
31-3106-004	1/10		●	LED	12V 24V	[A1]	2 pol. ASS2   2 pin ASS2 2,00 m
31-3102-034	1/20		●	LED	12V 24V	[A1]	2 pol. Superseal   2 pin Superseal 1,00 m
31-3103-024	1/10	●		LED	12V 24V	[A1]	offenes Ende mit Flachsteckern open end with contact pin 0,25 m
31-3102-024	1/25		●	LED	12V 24V	[A1]	offenes Ende mit Flachsteckern open end with contact pin 0,25 m
31-3100-004	1/10	●		LED	12V 24V	[A1]	P&R  2,00 m
			●			[A1]	P&R  2,00 m
31-3103-104	1/-	●		LED	12V 24V	[A1]	offenes Ende open end 0,25 m
31-3103-114	1/-	●		LED	12V 24V	[A1]	offenes Ende open end 2,00 m
31-3103-124	1/-	●		LED	12V 24V	[A1]	2 pol. Superseal   2 pin Superseal 2,00 m
31-3103-184	1/-	●		LED	12V 24V	[A1]	P&R  2,00 m
31-3103-204	1/-	●		LED	12V 24V	[A1]	2 pol. ASS2   2 pin ASS2 0,25 m
31-3103-214	1/-	●		LED	12V 24V	[A1]	2 pol. Superseal   2 pin Superseal 0,25 m
31-3104-034	1/-	●		LED	12V 24V	[A1]	P&R  0,50 m
31-3105-014	1/-	●		LED	12V 24V	[A1]	2 pol. ASS2   2 pin ASS2 0,50 m



# SUPERPOINT IV LED

ADR Zone 2

IP 69K



Produktinformation  
Product information

[A1]

[A2]

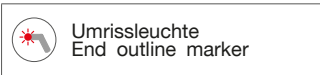
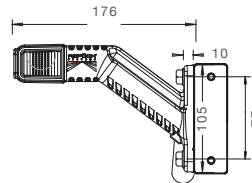
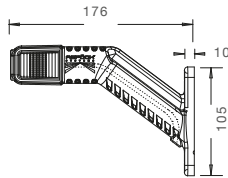

Umrissleuchte  
End outline marker

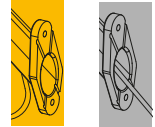

BEST. NR						ZUSATZ			ANSCHLUSS						
PART NO						ADD ON			CONNECTOR						
31-3105-024	1/-	●		LED	12V 24V	[A1]				2 pol. ASS3 2 pin ASS3	♀			1,50 m	
31-3105-034	1/-	●		LED	12V 24V	[A1]				2 pol. ASS2 2 pin ASS2	♀			2,00 m	
31-3105-044	1/-	●		LED	12V 24V	[A1]				2 pol. ASS2 2 pin ASS2	♀			0,75 m	
31-3164-004	1/50	●		LED	12V 24V	[A2]				P&R				0,75 m	
31-3165-004	1/40	●		LED	12V 24V	[A2]				2 pol. ASS2 2 pin ASS2	♀			1,50 m	
31-3102-104	1/-		●	LED	12V 24V	[A1]				offenes Ende open end				0,25 m	
31-3102-114	1/-		●	LED	12V 24V	[A1]				offenes Ende open end				2,00 m	
31-3102-124	1/-		●	LED	12V 24V	[A1]				2 pol. Superseal 2 pin Superseal	♂			2,00 m	
31-3102-184	1/-		●	LED	12V 24V	[A1]				P&R				2,00 m	
31-3102-204	1/-		●	LED	12V 24V	[A1]				2 pol. ASS2 2 pin ASS2	♀			0,25 m	
31-3102-214	1/-		●	LED	12V 24V	[A1]				Ecoled II 2 pol. Superseal 2 pin Superseal	♀			0,25 m	
31-3104-024	1/-		●	LED	12V 24V	[A1]				P&R				0,50 m	
31-3106-014	1/-		●	LED	12V 24V	[A1]				2 pol. ASS2 2 pin ASS2	♀			0,50 m	
31-3106-024	1/-		●	LED	12V 24V	[A1]				2 pol. ASS3 2 pin ASS3	♀			1,50 m	
31-3106-034	1/-		●	LED	12V 24V	[A1]				2 pol. ASS2 2 pin ASS2	♀			2,00 m	
31-3106-044	1/-		●	LED	12V 24V	[A1]				2 pol. ASS2 2 pin ASS2	♀			0,75 m	
31-3164-014	1/50		●	LED	12V 24V	[A2]				P&R				0,75 m	
31-3166-004	1/50		●	LED	12V 24V	[A2]				2 pol. ASS2 2 pin ASS2	♀			1,50 m	





# SUPERPOINT IV LED

ADR Zone 2 IP 69K



Produktinformation  
Product information

[B]

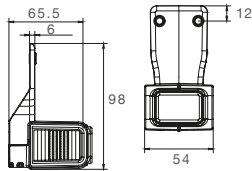

[C]

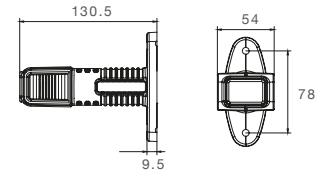

Umrissleuchte  
End outline marker

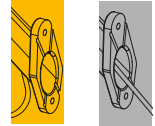

BEST. NR						ZUSATZ				ANSCHLUSS	
PART NO				LED	12V 24V	ADD ON				CONNECTOR	
31-3103-064	1/-	●		LED	12V 24V	[B]				offenes Ende open end	2,00 m
31-3103-144	1/-	●		LED	12V 24V	[C]				offenes Ende open end	2,00 m
31-3103-194	1/-	●		LED	12V 24V	[B]				2 pol. ASS3 2 pin ASS3	2,00 m
31-3104-084	1/-	●		LED	12V 24V	[B]				P&R	2,00 m
31-3102-064	1/-		●	LED	12V 24V	[B]				offenes Ende open end	2,00 m
31-3102-144	1/-		●	LED	12V 24V	[B]				offenes Ende open end	2,00 m
31-3102-194	1/-		●	LED	12V 24V	[B]				2 pol. ASS3 2 pin ASS3	2,00 m
31-3104-094	1/-		●	LED	12V 24V	[B]				P&R	2,00 m
31-3103-074	1/-	●		LED	12V 24V	[C]				offenes Ende open end	2,00 m
31-3103-134	1/-	●		LED	12V 24V	[C]				P&R	2,00 m
31-3103-154	1/-	●		LED	12V 24V	[D]				offenes Ende open end	2,00 m
31-3104-044	1/-	●		LED	12V 24V	[C]				P&R	2,00 m
31-3102-074	1/-		●	LED	12V 24V	[C]				offenes Ende open end	2,00 m
31-3102-134	1/-		●	LED	12V 24V	[C]				P&R	2,00 m
31-3102-154	1/-		●	LED	12V 24V	[C]				offenes Ende open end	2,00 m
31-3104-054	1/-		●	LED	12V 24V	[C]				P&R	2,00 m



# SUPERPOINT IV LED

ADR Zone 2 IP 69K



Produktinformation  
Product information

[D]

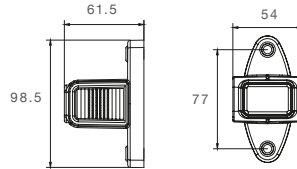

Umrissleuchte  
End outline marker

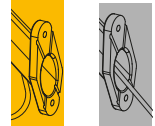

BEST. NR PART NO		←	→			ZUSATZ ADD ON			ANSCHLUSS CONNECTOR				
						[D]							
31-3103-044	1/-	●		LED	12V 24V	[D]				offenes Ende open end		2,00 m	
31-3103-164	1/-	●		LED	12V 24V	[B]				offenes Ende open end		2,00 m	
31-3104-104	1/-	●		LED	12V 24V	[D]				offenes Ende open end		4,50 m	
31-3104-114	1/-	●		LED	12V 24V	[D]				P&R		4,50 m	
31-3104-064	1/-	●		LED	12V 24V	[D]				P&R		2,00 m	
31-3102-044	1/-		●	LED	12V 24V	[D]				offenes Ende open end		2,00 m	
31-3102-164	1/-		●	LED	12V 24V	[D]				offenes Ende open end		2,00 m	
31-3104-124	1/-		●	LED	12V 24V	[D]				P&R		4,50 m	
31-3104-134	1/-		●	LED	12V 24V	[D]				offenes Ende open end		4,50 m	
31-3104-074	1/-		●	LED	12V 24V	[D]				P&R		2,00 m	



# SUPERPOINT IV LED

ZUBEHÖR / ACCESSORIES

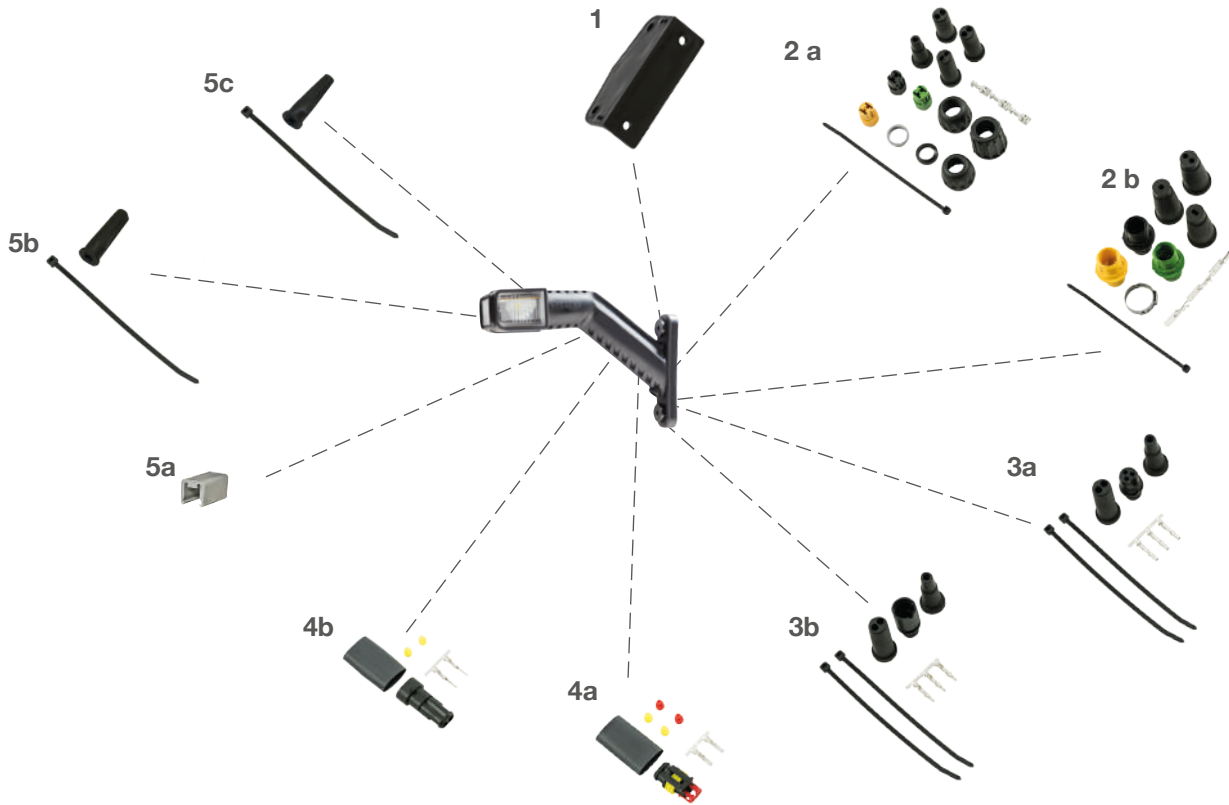

**1** Befestigungswinkel für Leuchtarm |  
angle bracket for end outline marker  
..... 15-5313-004

**2** ASS1 & ASS2 Verbinder |  
ASS1 & ASS2 connector  
(a) 2 pol. weiblich  
2 pin female ..... 13-5626-401   
(b) 2 pol. männlich  
2 pin male ..... 13-5625-991

**3** ASS3 Verbinder |  
ASS3 connector  
(a) 3 pol. weiblich  
3 pin female ..... 13-0322-281   
(b) 3 pol. männlich  
3 pin male ..... 13-0332-281

**4** Superseal Verbinder | Superseal connector  
(a) 2 pol. weiblich  
2 pin female ..... 15-7002-044   
(b) 2 pol. männlich  
2 pin male ..... 15-7002-054

**5** für P&R Verbinder |  
for P&R connector  
(a) Verschlusskappen  
caps ..... 15-5971-014   
(b) Endkappen rund  
end caps round ..... 15-5983-024   
(c) Endkappen eckig  
end caps square ..... 15-5729-014

# SUPERPOINT III LED





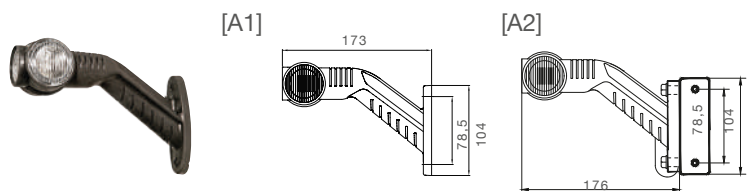



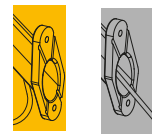









































































































ADR Zone 2  IP 69K

Umrissleuchte  
End Outline  
Marker



 Umrissleuchte  
End outline marker



BEST. NR						ZUSATZ			ANSCHLUSS							
PART NO						ADD ON			CONNECTOR							
31-3365-094	1/20	●		LED	24V	[A2]				2 pol. ASS2 2 pin ASS2	♀				1,50 m	
31-3366-094	1/20		●	LED	24V	[A2]				2 pol. ASS2 2 pin ASS2	♀				1,50 m	
31-3300-074	1/15	●	●	LED	24V	[A1]				offenes Ende open end					4,00 m	
31-3302-054	1/20	●		LED	24V	[A1]				2 pol. Superseal 2 pin Superseal	♀				0,50 m	
31-3303-054	1/20		●	LED	24V	[A1]				2 pol. Superseal 2 pin Superseal	♀				0,50 m	
31-3304-044	1/25	●		LED	24V	[A1]				P&R					1,25 m	
31-3304-054	1/25		●	LED	24V	[A1]				P&R					1,25 m	
31-3304-114	1/-		●	LED	24V	[A1]				P&R					1,25 m	
31-3304-124	1/-	●		LED	24V	[A1]				P&R					1,25 m	
31-3304-134	1/25		●	LED	24V	[A1]				P&R					1,75 m	
31-3304-144	1/25	●		LED	24V	[A1]				P&R					1,75 m	
31-3305-014	1/30	●		LED	24V	[A1]				2 pol. ASS2 2 pin ASS2	♀				1,75 m	
31-3305-044	1/-	●		LED	24V	[A1]				2 pol. ASS2 2 pin ASS2	♀				2,00 m	
31-3305-124	1/-	●		LED	24V	[A1]				3 pol. ASS3 3 pin ASS3	♀				1,25 m	
31-3305-214	1/-	●		LED	24V	[A1]				2 pol. ASS2 2 pin ASS2	♀				0,50 m	
31-3305-294	1/50	●		LED	24V	[A1]				2 pol. Superseal 2 pin Superseal	♂				0,50 m	
31-3306-014	1/15		●	LED	24V	[A1]				2 pol. ASS2 2 pin ASS2	♀				1,50 m	



# SUPERPOINT III LED

ADR Zone 2 IP 69K

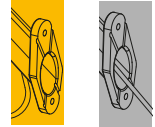
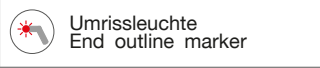
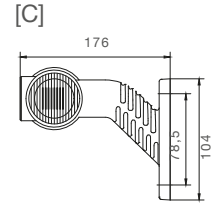
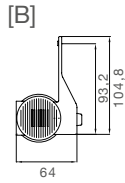

BEST. NR						ZUSATZ				ANSCHLUSS					
PART NO						ADD ON				CONNECTOR					
31-3306-044	1/-		●	LED	24V	[A1]				2 pol. ASS2 2 pin ASS2	♀			2,00 m	
31-3306-124	1/-		●	LED	24V	[A1]				3 pol. ASS3 3 pin ASS3	♀			1,25 m	
31-3306-214	1/-		●	LED	24V	[A1]				2 pol. ASS2 2 pin ASS2	♀			0,50 m	
31-3306-294	1/50		●	LED	24V	[A1]				2 pol. Superseal 2 pin Superseal	♂			0,50 m	
31-3362-004	1/-		●	LED	24V	[B]				2 pol. Superseal 2 pin Superseal	♀			0,25 m	
31-3362-104	1/50		●	LED	24V	[B]				2 pol. Superseal 2 pin Superseal	♂			1,50 m	
31-3363-004	1/-	●		LED	24V	[B]				2 pol. Superseal 2 pin Superseal	♀			0,25 m	
31-3363-104	1/50	●		LED	24V	[B]				2 pol. Superseal 2 pin Superseal	♂			1,50 m	
31-3364-024	1/50		●	LED	24V	[B]				P&R				1,50 m	
31-3364-054	1/40	●		LED	24V	[B]				P&R				1,50 m	
31-3365-014	1/-	●		LED	24V	[B]				offenes Ende open end				4,00 m	
31-3365-054	1/-	●		LED	24V	[B]				2 pol. ASS2 2 pin ASS2	♀			0,25 m	
31-3365-064	1/-	●		LED	24V	[B]				3 pol. ASS3 3 pin ASS3	♀			1,50 m	
31-3366-024	1/-		●	LED	24V	[B]				offenes Ende open end				4,00 m	
31-3366-054	1/-		●	LED	24V	[B]				2 pol. ASS2 2 pin ASS2	♀			0,25 m	
31-3366-064	1/-		●	LED	24V	[B]				3 pol. ASS3 3 pin ASS3	♀			1,50 m	
31-3305-084	1/50	●		LED	24V	[C]				Europoint II				0,04 m	
31-3306-084	1/-		●	LED	24V	[C]				offenes Ende open end				0,04 m	



# SUPERPOINT III LED

ADR Zone 2

IP 69K

Umrissleuchte  
End Outline  
Marker

[D]

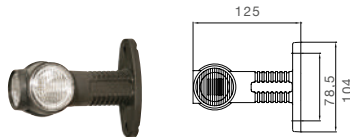

[E]

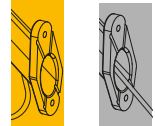
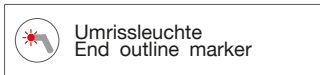
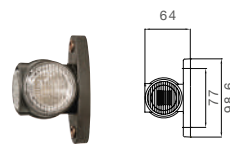

BEST. NR						ZUSATZ				ANSCHLUSS		
PART NO						ADD ON				CONNECTOR		
31-3300-244	1/30	●	●	LED	24V	[D]				offenes Ende open end	4,00 m	
31-3302-064	1/-		●	LED	24V	[D]				2 pol. Superseal 2 pin Superseal	♀	0,50 m
31-3303-064	1/-	●		LED	24V	[D]				2 pol. Superseal 2 pin Superseal	♀	0,50 m
31-3304-094	1/25	●	●	LED	24V	[D]				P&R		1,25 m
31-3305-194	1/-	●		LED	24V	[D]				2 pol. ASS2 2 pin ASS2	♀	2,00 m
31-3306-194	1/-		●	LED	24V	[D]				2 pol. ASS2 2 pin ASS2	♀	2,00 m
31-3307-014	1/25	●	●	LED	24V	[D]				2 pol. ASS2 2 pin ASS2	♀	1,75 m
31-3307-024	1/-	●	●	LED	24V	[D]				3 pol. ASS3 3 pin ASS3	♀	1,75 m
31-3307-104	1/25	●	●	LED	24V	[D]				2 pol. ASS2 2 pin ASS2	♀	2,50 m
31-3307-194	1/40	●	●	LED	24V	[D]				2 pol. Superseal 2 pin Superseal	♂	2,00 m
31-3300-374	1/-	●	●	LED	24V	[E]				2 pol. Superseal 2 pin Superseal	♀	3,00 m
31-3307-044	1/-	●	●	LED	24V	[E]				2 pol. ASS2 2 pin ASS2	♀	1,50 m
31-3307-134	1/-	●	●	LED	24V	[E]				2 pol. ASS2 2 pin ASS2	♀	3,00 m
31-3307-224	1/50	●	●	LED	24V	[E]				3 pol. ASS3 3 pin ASS3	♀	0,50 m
31-3360-004	1/20	●	●	LED	24V	[E]				offenes Ende open end	4,00 m	
31-3364-004	1/25	●	●	LED	24V	[E]				P&R		1,50 m
31-3367-004	1/50	●	●	LED	24V	[E]				2 pol. ASS2 2 pin ASS2	♀	0,50 m



# SUPERPOINT III LED

ZUBEHÖR / ACCESSORIES

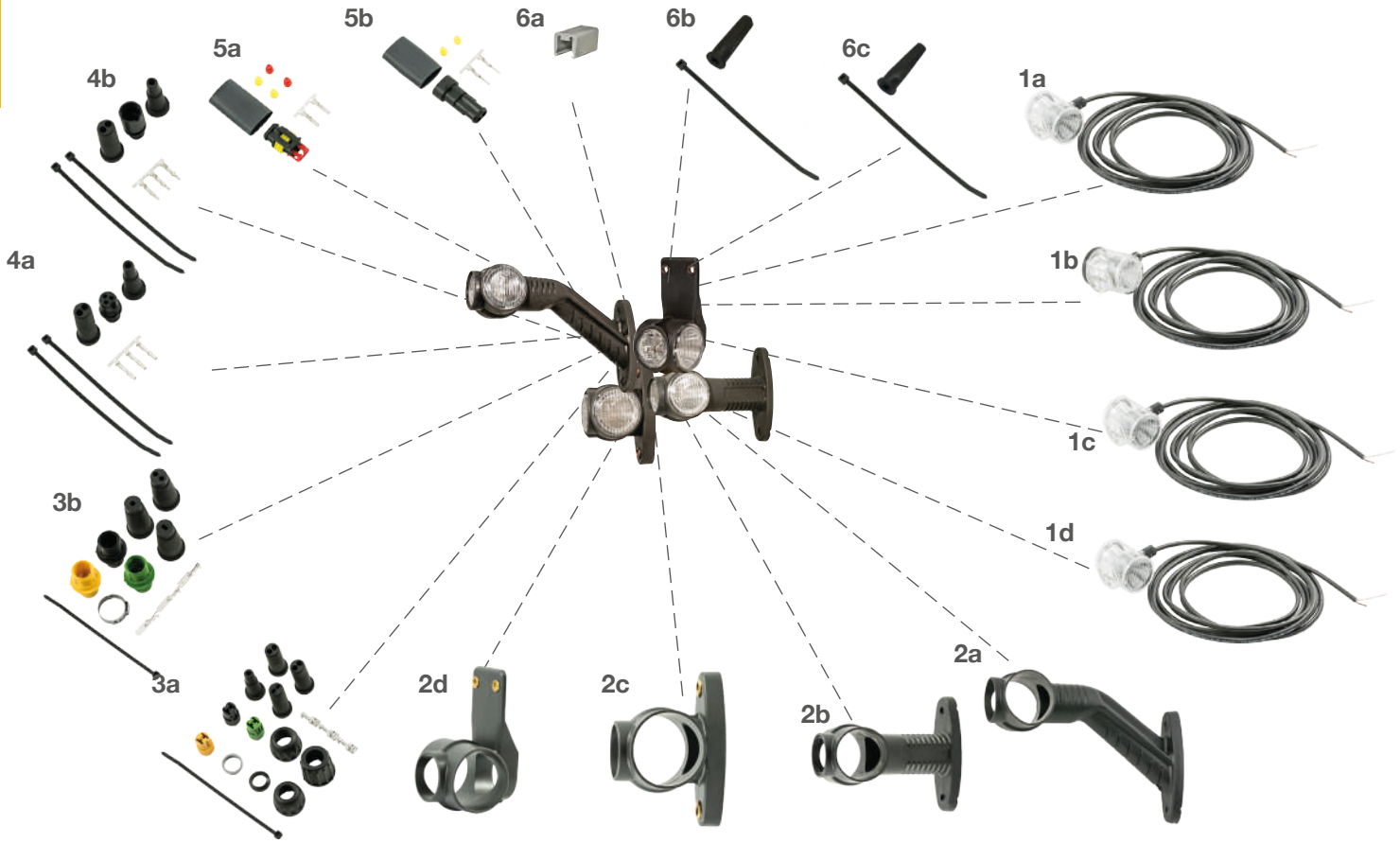

## 1 Lichtscheibe | lens

- (a) rot/weiß/orange mit 4,00 m Kabel  
red/white/orange with 4,00 m cable ..... 21-3351-704
- (b) schwarz/weiß/orange mit 4,00 m Kabel  
black/white/orange with 4,00 m cable ..... 21-3350-704
- (c) rot/weiß/orange mit 1,50 m Kabel  
red/white/orange with 1,50 m cable ..... 21-3353-704
- (d) rot/weiß/orange mit 3,00 m Kabel  
red/white/orange with 3,00 m cable ..... 21-3354-704

## 2 Umrißarm | end outline marker

- (a) Standard  
Standard..... 21-3300-007
- (b) gerade  
straight ..... 21-3302-007
- (c) Direktanbau  
direct mounting ..... 15-5325-004
- (d) mit Pendelhalter  
with pendular bracket.. 15-5325-101

## 3 ASS1 & ASS2 Verbinder | ASS1 & ASS2 connector

- (a) 2 pol. weiblich  
2 pin female ..... 13-5626-401
- (b) 2 pol. männlich  
2 pin male ..... 13-5625-991

## 4 ASS3 Verbinder | ASS3 connector

- (a) 3 pol. weiblich  
3 pin female ..... 13-0322-281
- (b) 3 pol. männlich  
3 pin male ..... 13-0332-281

## 5 Superseal Verbinder | Superseal connector

- (a) 2 pol. weiblich  
2 pin female ..... 15-7002-044
- (b) 2 pol. männlich  
2 pin male ..... 15-7002-054

## 6 für P&R Verbinder | for P&R connector

- (a) Verschlusskappen  
caps..... 15-5971-014
- (b) Endkappen rund  
end caps round..... 15-5983-024
- (c) Endkappen eckig  
end caps square..... 15-5729-014



# SUPERPOINT II

ADR  
Zone 2

IP 68

Umrissleuchte  
End Outline  
Marker

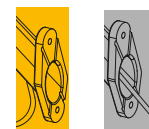
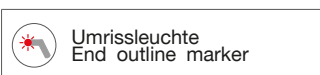
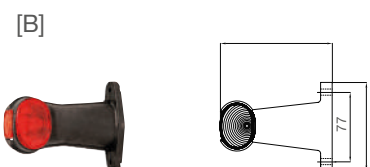
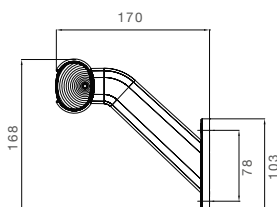

BEST. NR	PART NO	←	→	Light	V	ZUSATZ	ANSCHLUSS	CONNECTOR	Length	Symbol
						ADD ON				
31-3404-014	1/20	●		Light	24V	[A1]	P&R	1,25 m	Symbol	
31-3404-104	1/25	●		Light	24V	[A1]	P&R	1,80 m	Symbol	
31-3404-124	1/-	●		Light	24V	[A1]	P&R	1,25 m	Symbol	
31-3404-364	-/-	●		Light	24V	[A2]	P&R	1,80 m	Symbol	
31-3405-004	1/-	●		Light	24V	[A1]	2 pol. ASS2 2 pin ASS2	1,75 m	Symbol	
31-3405-074	-/-	●		Light	24V	[A1]	3 pol. ASS3 3 pin ASS3	1,25 m	Symbol	
31-3407-114	1/-	●		Light	24V	[A1]	2 pol. ASS2 2 pin ASS2	0,50 m	Symbol	
31-3404-004	1/20		●	Light	24V	[A1]	P&R	1,25 m	Symbol	
31-3404-064	1/-		●	Light	24V	[A1]	P&R	1,80 m	Symbol	
31-3404-114	-/-		●	Light	24V	[A1]	P&R	1,80 m	Symbol	
31-3404-134	1/25		●	Light	24V	[A1]	P&R	1,30 m	Symbol	
31-3406-004	1/35		●	Light	24V	[A1]	2 pol. ASS2 2 pin ASS2	1,75 m	Symbol	
31-3406-064	1/25		●	Light	24V	[A1]	3 pol. ASS3 3 pin ASS3	1,25 m	Symbol	
31-3407-104	1/-		●	Light	24V	[A1]	2 pol. ASS2 2 pin ASS2	0,50 m	Symbol	
31-3704-004	1/45	●	●	Light	24V	[B]	P&R	0,50 m	Symbol	
31-3704-014	1/50	●	●	Light	24V	[B]	P&R	1,50 m	Symbol	
31-3707-024	1/25	●	●	Light	24V	[B]	2 pol. ASS2 2 pin ASS2	1,75 m	Symbol	
31-3707-105	1/20	●		Light	24V	[B]	2 pol. ASS2 2 pin ASS2	2,00 m	Symbol	





# SUPERPOINT II

[C]

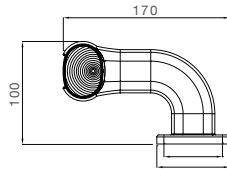

[D]

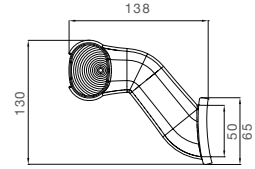

Umrissleuchte  
End outline marker

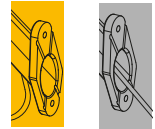

BEST. NR	PART NO	Box	←	→	Light	V	ZUSATZ	ANSCHLUSS
							ADD ON	CONNECTOR
31-3707-144	1/-	●		●	Light	24V	[B]	2 pol. ASS2 2 pin ASS2 ♀   0,50 m
31-3793-004	1/20	●		●	Light	24V	[B]	2 pol. Superseal 2 pin Superseal ♀   0,50 m
31-3707-095	1/25		●		Light	24V	[B]	2 pol. ASS2 2 pin ASS2 ♀   2,00 m
31-3707-134	1/-	●		●	Light	24V	[B]	2 pol. ASS2 2 pin ASS2 ♀   0,50 m
31-3792-004	1/20		●		Light	24V	[B]	2 pol. Superseal 2 pin Superseal ♀   0,50 m
31-3804-014	1/-	●			Light	24V	[C]	P&R   1,40 m
31-3805-004	1/-	●			Light	24V	[C]	2 pol. ASS2 2 pin ASS2 ♀   1,75 m
31-3805-024	-/-	●			Light	24V	[C]	2 pol. ASS3 2 pin ASS3 ♀   1,75 m
31-3804-004	1/-	●			Light	24V	[C]	P&R   1,40 m
31-3806-004	1/-		●		Light	24V	[C]	2 pol. ASS2 2 pin ASS2 ♀   1,75 m
31-3806-024	-/-		●		Light	24V	[C]	2 pol. ASS3 2 pin ASS3 ♀   1,75 m
31-3604-044	1/25		●		Light	24V	[D]	P&R   1,40 m
31-3606-004	1/-		●		Light	24V	[D]	2 pol. ASS2 2 pin ASS2 ♀   1,75 m
31-3608-004	1/25		●		Light	24V	[D]	offenes Ende open end 0,45 m
31-3604-054	1/30	●			Light	24V	[D]	P&R   1,40 m
31-3605-004	1/-	●			Light	24V	[D]	2 pol. ASS2 2 pin ASS2 ♀   1,70 m
31-3608-014	1/50	●			Light	24V	[D]	offenes Ende open end 0,45 m

# SUPERPOINT II

ZUBEHÖR / ACCESSORIES

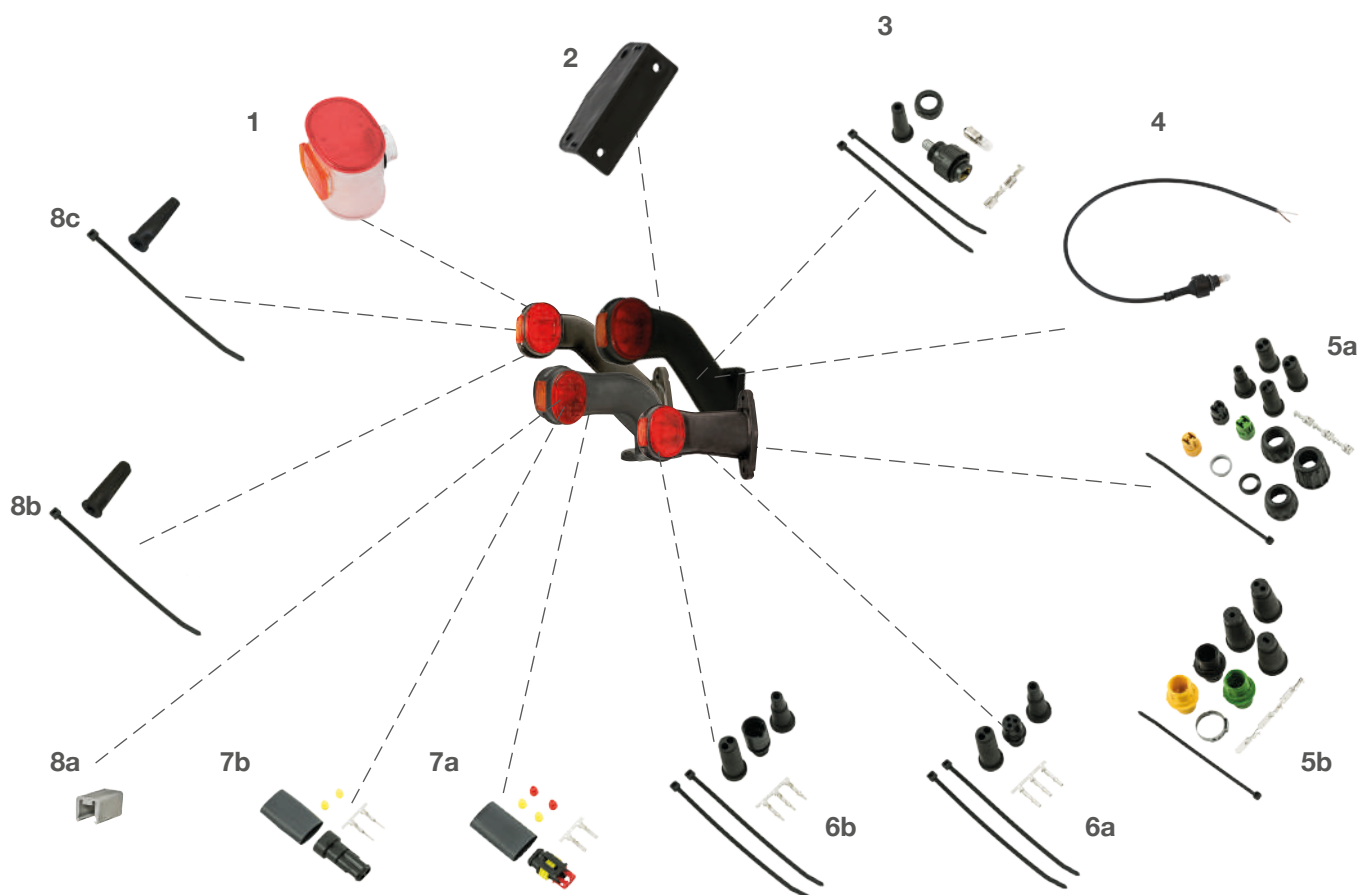

**1** Lichtscheibe | lens  
rot/weiß/orange  
red/white/orange  
..... 18-8136-004 

**2** Befestigungswinkel für Leuchtarm |  
angle bracket for end outline marker  
..... 15-5313-004 

**3** gerade Anschluss | straight connector  
..... 15-2128-544 

**4** Glühlampenanschluss | bulb connection  
inkl. Glühlampe und 0,5 m Kabel  
including bulb and 0,5 m cable  
..... 31-2800-004

**5** ASS1 & ASS2 Verbinder |  
ASS1 & ASS2 connector  
(a) 2 pol. weiblich  
2 pin female ..... 13-5626-401   
(b) 2 pol. männlich  
2 pin male ..... 13-5625-991 

**6** ASS3 Verbinder | ASS3 connector  
(a) 3 pol. weiblich  
3 pin female ..... 13-0322-281   
(b) 3 pol. männlich  
3 pin male ..... 13-0332-281 

**7** Superseal Verbinder | Superseal connector  
(a) 2 pol. weiblich  
2 pin female ..... 15-7002-044   
(b) 2 pol. männlich  
2 pin male ..... 15-7002-054 

**8** für P&R Verbinder |  
for P&R connector  
(a) Verschlusskappen  
caps ..... 15-5971-014   
(b) Endkappen rund  
end caps round ..... 15-5983-024   
(c) Endkappen eckig  
end caps square ..... 15-5729-014 



# FLEXIPOINT II LED

ADR  
Zone 2

IP 54



Produktinformation  
Product information

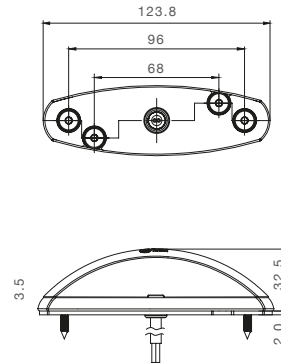
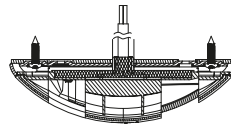
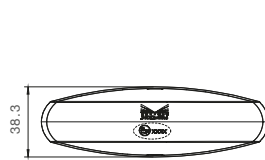

Umrissleuchte  
End outline marker

BEST. NR		←	→			ZUSATZ	ANSCHLUSS	
PART NO						ADD ON	CONNECTOR	
31-8524-004	1/20	●	●	LED	12V 24V	klare Lichtscheibe	offenes Ende open end	1,50 m
31-8524-014	1/20	●	●	LED	12V 24V	klare Lichtscheibe	DC Flachkabel DC flat cable	2,50 m
31-8524-024	1/20	●		LED	12V 24V	klare Lichtscheibe	DC Flachkabel DC flat cable	2,50 m
31-8524-044	1/20		●	LED	12V 24V	klare Lichtscheibe	DC Flachkabel DC flat cable	5,00 m



# FLEXIPOINT II LED

ZUBEHÖR / ACCESSORIES

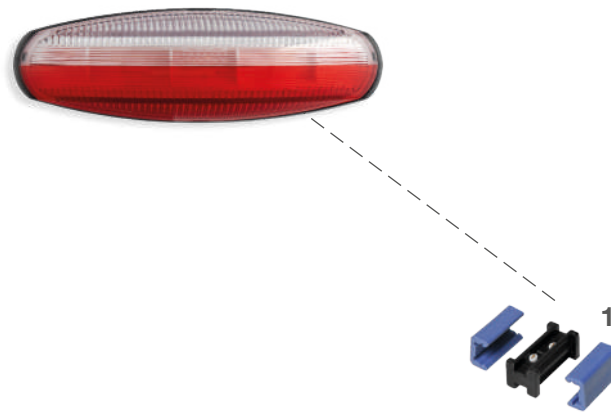

- 1** DC-Verbinder (10 Sackerl) |  
DC connector (10 bags)  
..... 15-5976-034 



# FLEXIPOINT I LED



[A]

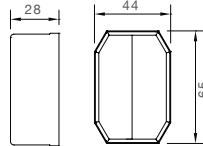

[B]

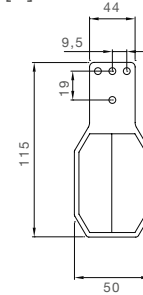

BEST. NR PART NO		←	→			ZUSATZ ADD ON			ANSCHLUSS CONNECTOR			
						[A]						
31-6300-004	1/-	●	●	LED	12V 24V	[A]			offenes Ende open end		1,00 m	
31-6304-014	1/-	●	●	LED	12V 24V	[A]			P&R		1,00 m	
31-6364-004	1/-	●		LED	12V 24V	[B]			P&R		1,00 m	
31-6364-014	1/-		●	LED	12V 24V	[B]			P&R		1,00 m	



# FLEXIPOINT I LED

ZUBEHÖR / ACCESSORIES

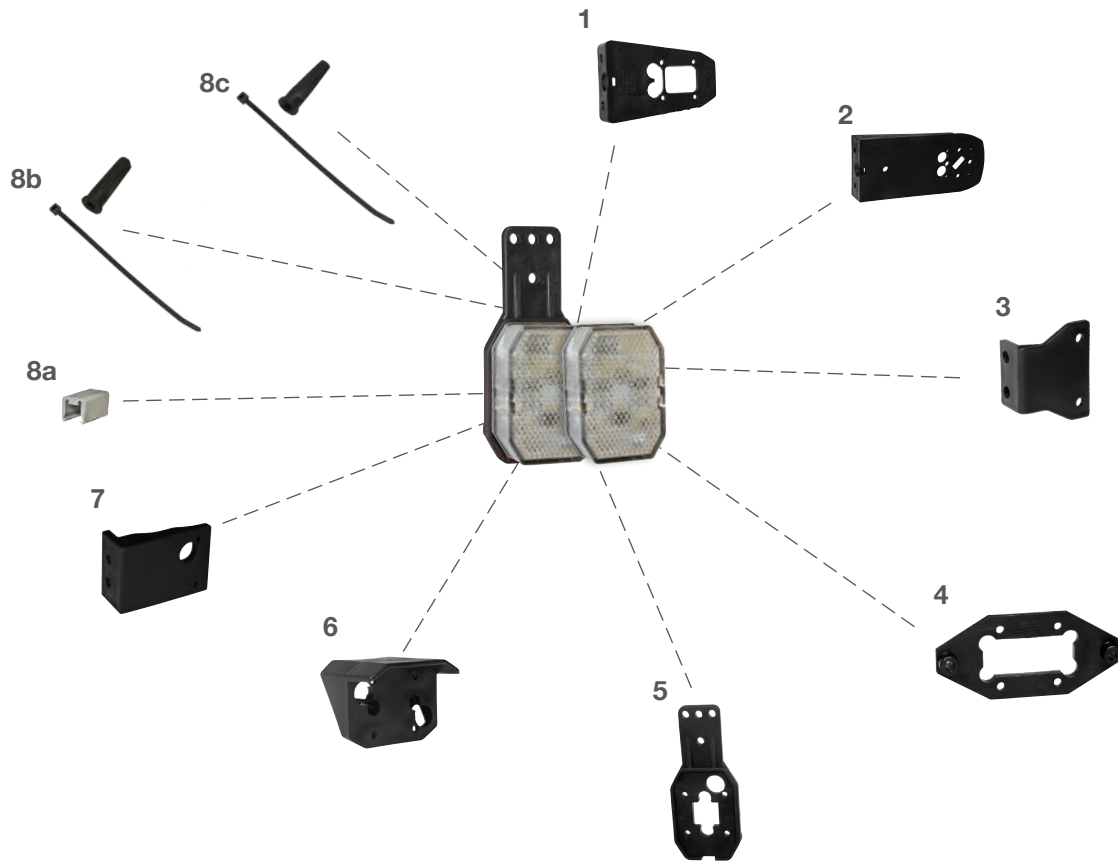

**1** Aufhängelasche 100 mm |  
bracket 100 mm  
..... 15-5310-104

**2** Aufhängelasche 150 mm |  
bracket 150 mm  
..... 15-5311-004

**3** 90° Winkelhalter | 90° bracket  
..... 15-5318-004

**4** wendbare Halteplatte | turnable flat bracket  
..... 15-5316-004

**5** flexibler gerader Gummihalter |  
flexible straight rubber bracket  
..... 15-5312-104

**6** Kotflügelhalter | mud guard bracket  
..... 15-5314-104

**7** Winkelhalter soft | soft bracket  
..... 15-5316-704

**8** für P&R Verbinder | for P&R connector  
(a) Verschlusskappen  
caps..... 15-5971-014   
(b) Endkappen rund  
end caps round..... 15-5983-024   
(c) Endkappen eckig  
end caps square..... 15-5729-014



# FLEXIPOINT I



[A]

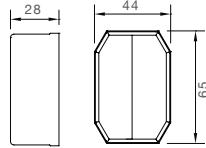

[B]

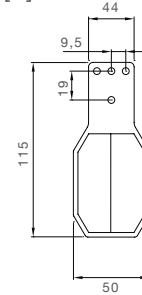

BEST. NR PART NO		←	→			ZUSATZ ADD ON			ANSCHLUSS CONNECTOR			
						[A]	[B]					
31-6504-084	1/-	●	●		24V	[A]			P&R		0,50 m	
31-6504-134	-/-	●	●		24V	[A]			P&R		2,00 m	
31-6504-104	-/-	●	●		24V	[A]			P&R		0,25 m	
31-6504-174	1/-	●	●		24V	[A]			P&R		0,50 m	
31-6564-064	1/-		●		24V	[B]			P&R		0,50 m	
31-6564-074	1/50	●			24V	[B]			P&R		0,50 m	
31-6564-144	1/-		●		24V	[B]			P&R		1,50 m	
31-6564-154	1/25	●			24V	[B]			P&R		1,50 m	



# FLEXIPOINT I

ZUBEHÖR / ACCESSORIES

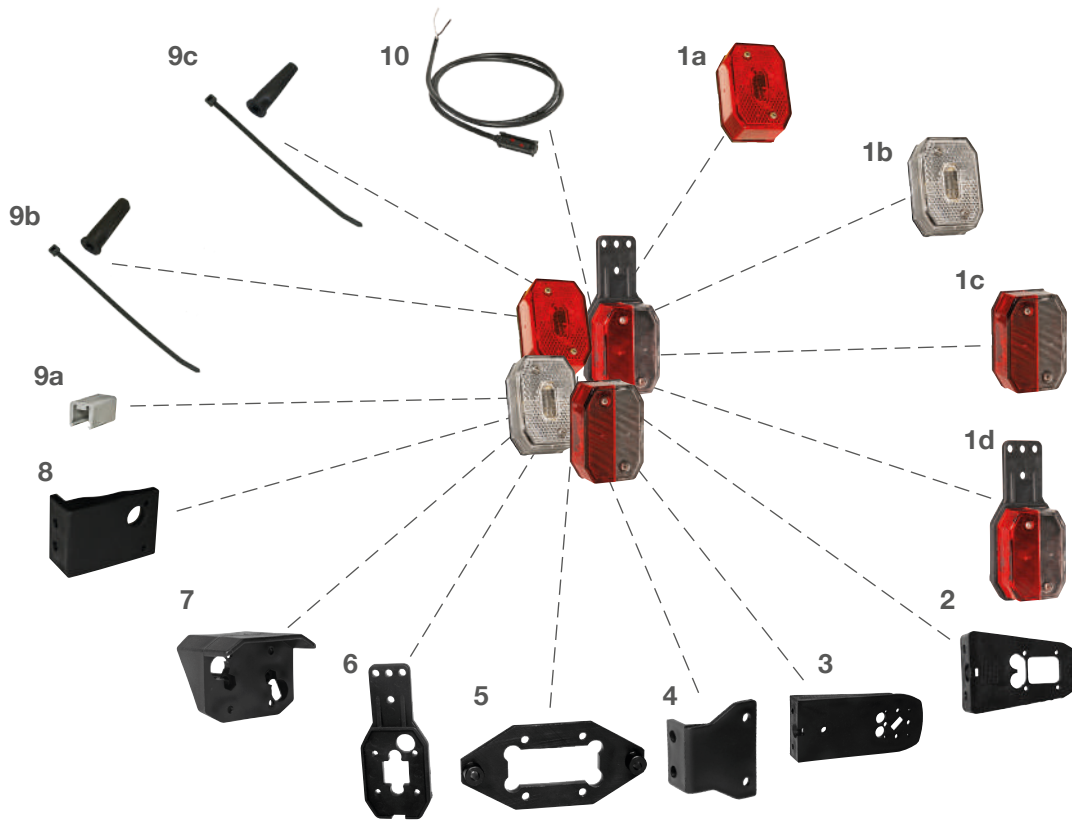

- 1 Ersatzteileuchte | spare part lamp**
- (a) rot ..... 21-6510-004
  - (b) weiß ..... 21-6512-004
  - (c) rot/weiß ..... 21-6513-004
  - (d) rot/weiß mit Aufhängelasche  
red/white with bracket. 21-6513-214

- 2 Aufhängelasche 100 mm |  
bracket 100 mm**
- ..... 15-5310-104

- 3 Aufhängelasche 150 mm |  
bracket 150 mm**
- ..... 15-5311-004

- 4 90° Winkelhalter | 90° bracket**
- ..... 15-5318-004

- 5 wendbare Halteplatte | turnable flat bracket**
- ..... 15-5316-004

- 6 flexibler gerader Gummihalter |  
flexible straight rubber bracket**
- ..... 15-5312-104

- 7 Kotflügelhalter | mud guard bracket**
- ..... 15-5314-104

- 8 Winkelhalter soft | soft bracket**
- ..... 15-5316-704

- 9 für P&R Verbinder | for P&R connector**
- (a) Verschlusskappen  
caps..... 15-5971-014
  - (b) Endkappen rund  
end caps round..... 15-5983-024
  - (c) Endkappen eckig  
end caps square..... 15-5729-014

- 10 Zuleitung P&R | front connection P&R**
- 0,5 m..... 68-5000-574
  - 1,5 m..... 68-5000-604
  - 5,0 m..... 68-5000-634